

## FITTING INSTRUCTION

Clamp mark in acc. with		Cables joining
ISO	PN	
1	L	Left directional lights
2	+	Rear fog lights
3	31	Ground
4	R	Right directional lights
5	58R	Right side parking lights
6	54	Stoplights
7	58L	Left side parking lights

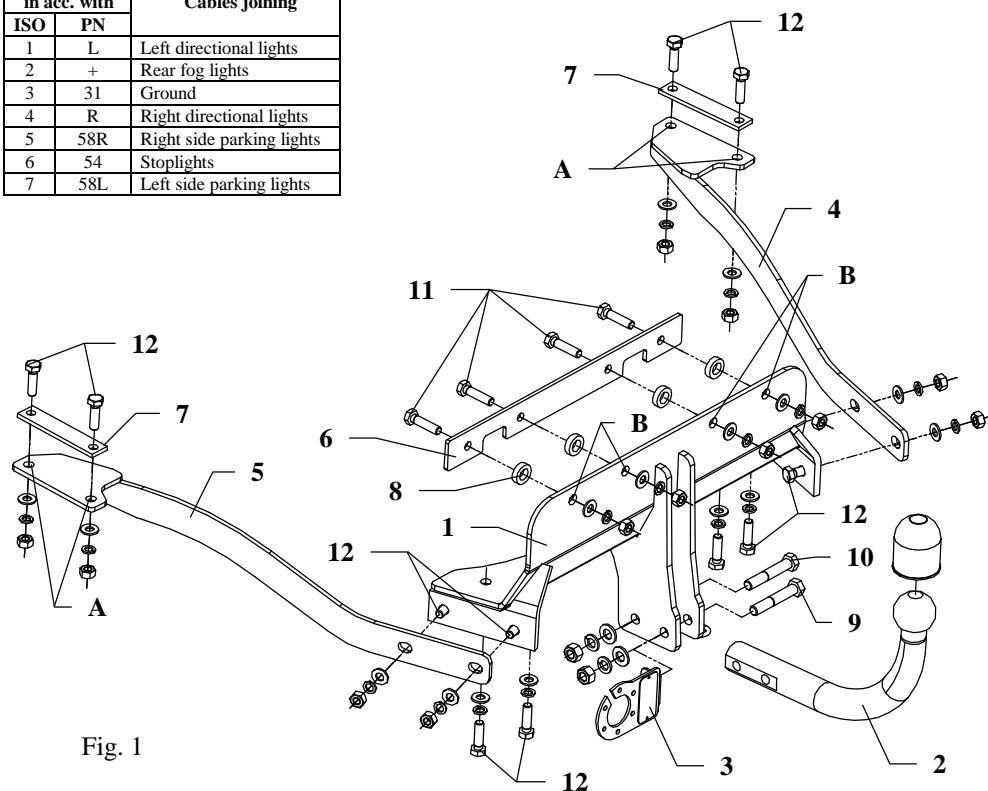

Fig. 1

This towbar is designed to assembly in following cars:  
**BMW series 7, E38, 4 doors**, produced since 06.1994 till 08.2001, catalogue no. **B07** and is prepared to tow trailers max total weight **2200 kg** and max vertical load **90 kg**.

### From manufacturer

Thank you for buying our product. Their reliability has been confirmed in many tests. Reliability of towbar depends also on correct assembly and right operation. For this reasons we kindly ask to read carefully this instruction and apply to hints.

*The towbar should be install in points described by a car producer.*

## The instruction of the assembly

1. For the purpose of installings of the towbar one ought to disassemble the casings of the rear plate and floor.
2. Disassemble the bumper.
3. Remove a muffler from last handle. Take out the heat-proof casing.
4. In the back piece (from the internal side) and on the floor, in places by machinery marked, drill holes  $\varnothing 10,5\text{mm}$  which will be covered with holes of the towbar (pos. A and B).
5. To so prepared holes, apply the main plate (pos. 1) and fix using bolts M10x40mm (pos. 11). Use the distance sleeves  $\varnothing 25$ ; L=7mm (pos. 8) and plate (pos. 6). Look at the drawing 1.
6. Fix side brackets (pos. 4 and 5) together with fish-plates (pos. 7) to the main plate of the towbar (pos. 1) and to the floor. See the drawing 1.
7. Install the bumper after cut out its fragment. See the drawing 2.
8. Fix all previously unscrewed elements.
9. Fix tow ball (pos. 2) using bolt M12x75mm (pos. 9) and M12x70mm (pos. 10). With bolt M12x75mm fix also a socket plate (pos. 3). See figure 1.
10. Tighten all bolts according to the torque shown in the table.
11. Connect electric wires of 7-poles socket according to the instruction of the car. (Recommend to make at authorized service station).
12. Complete paint layer damaged during installation.

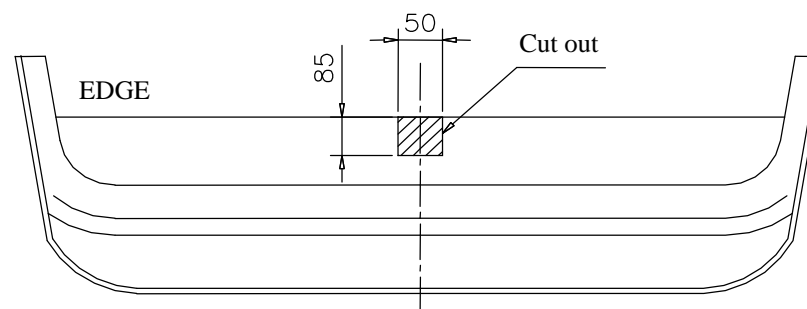

Fig. 2

Torque settings for nuts and bolts (8,8):	
<b>M 8 - 25 Nm</b>	<b>M 10 - 55 Nm</b>
<b>M 12 - 85 Nm</b>	<b>M 14 - 135 Nm</b>











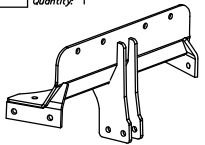
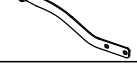
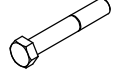

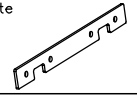

### NOTE

After install the towbar you should get adequate note in registration book (at authorised service station). The car should be equipped with:

- Indicators
- Tow mirrors

After 1000km check all bolts and nuts. The ball of towbar must be always kept clear and conserve with a grease.

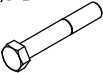
## Towbar accessories:

Pos. 1 Name: Main plate Quantity: 1 	Pos. 5 Name: Left bracket Quantity: 1 	Pos. 10 Name: Bolt 8,8 B Quantity: 1 Dim.: M12x70mm 	Pos. 15 Name: Plain washer Quantity: 2 Dim.: ø 13 mm 
Pos. 2 Name: Tow ball Quantity: 1 	Pos. 6 Name: Plate Quantity: 1 	Pos. 11 Name: Bolt 8,8 B Quantity: 4 Dim.: M10x40mm 	Pos. 16 Name: Plain washer Quantity: 16 Dim.: ø 10,5 mm 
Pos. 3 Name: Socket plate Quantity: 1 	Pos. 7 Name: Fish-plate Quantity: 2 	Pos. 12 Name: Bolt 8,8 B Quantity: 12 Dim.: M10x35mm 	Pos. 17 Name: Spring washer Quantity: 2 Dim.: ø 12,2 mm 
Pos. 4 Name: Right bracket Quantity: 1 	Pos. 8 Name: Distance sleeve Quantity: 4 Dim.: ø25xø15mm L=7mm 	Pos. 13 Name: Nut 8 B Quantity: 2 Dim.: M12 	Pos. 18 Name: Spring washer Quantity: 16 Dim.: ø 10,2 mm 
	Pos. 9 Name: Bolt 8,8 B Quantity: 1 Dim.: M12x75mm 	Pos. 14 Name: Nut 8 B Quantity: 12 Dim.: M10 	Pos. 19 Name: Ball cover Quantity: 1 



## PPUH AUTO-HAK S.J.

Produkcja Haków Holowniczych  
Henryk & Zbigniew Nejman  
76-200 SŁUPSK ul. Słoneczna 16K  
tel/fax (059) 8-414-414; 8-414-413  
E-mail: [office@autohak.com.pl](mailto:office@autohak.com.pl)  
[www.autohak.com.pl](http://www.autohak.com.pl)

## Towing hitch (without electrical set)

Class: A50-X Cat. no. B07

Designed for:

Manufacturer: BMW

Model: series 7

Type: 4 doors

produced since 06.1994 till 08.2001

Technical data:

D-value: 11,79 kN

maximum trailer weight: 2200 kg

maximum vertical cup load: 90 kg

Approval number acc. to regulations EKG/ONZ 55.01: **E20-55R-01 1115**

## Foreword

This towbar is designed according to rules of safety traffic regulations. The towing hitch is a safety component and can be install only by qualified personnel. Any alteration or conversion of the towing hitch is prohibited and would lead to cancellation of design certification. Remove insulating compound and underseal from vehicle (if present) in the area of the matting surfaces of the towing hitch. The vehicle manufacturer's specifications regarding trailer load and max. vertical cup load are decisive for driving whereat values for the towing hitch cannot be exceeded.

D-value formula:

$$\frac{\text{Max trailer weight [kg]} \times \text{Max vehicle weight [kg]}}{\text{Max trailer weight [kg]} + \text{Max vehicle weight [kg]}} \times \frac{9,81}{1000} = D \text{ [kN]}$$